

N - CHANNEL ENHANCEMENT MODE FAST POWER MOS TRANSISTOR

| TYPE | V _{DSS} | R _{DS(on)} | I _D |
|------------|------------------|---------------------|----------------|
| STP6NA60 | 600 V | < 1.2 Ω | 6.5 A |
| STP6NA60FI | 600 V | < 1.2 Ω | 3.9 A |

- TYPICAL R_{DS(on)} = 1 Ω
- ± 30V GATE TO SOURCE VOLTAGE RATING
- 100% AVALANCHE TESTED
- REPETITIVE AVALANCHE DATA AT 100°C
- LOW INTRINSIC CAPACITANCES
- GATE CHARGE MINIMIZED
- REDUCED THRESHOLD VOLTAGE SPREAD

DESCRIPTION

This series of POWER MOSFETS represents the most advanced high voltage technology. The optimized cell layout coupled with a new proprietary edge termination concur to give the device low R_{DS(on)} and gate charge, unequalled ruggedness and superior switching performance.

APPLICATIONS

- HIGH CURRENT, HIGH SPEED SWITCHING
- SWITCH MODE POWER SUPPLIES (SMPS)
- DC-AC CONVERTERS FOR WELDING EQUIPMENT AND UNINTERRUPTIBLE POWER SUPPLIES AND MOTOR DRIVE



ABSOLUTE MAXIMUM RATINGS

| Symbol | Parameter | Value | | Unit |
|---------------------|---|------------|------------|------|
| | | STP6NA60 | STP6NA60FI | |
| V _{DS} | Drain-source Voltage (V _{GS} = 0) | 600 | | V |
| V _{DGR} | Drain-gate Voltage (R _{GS} = 20 kΩ) | 600 | | V |
| V _{GS} | Gate-source Voltage | ± 30 | | V |
| I _D | Drain Current (continuous) at T _c = 25 °C | 6.5 | 3.9 | A |
| I _D | Drain Current (continuous) at T _c = 100 °C | 4.3 | 2.6 | A |
| I _{DM} (•) | Drain Current (pulsed) | 26 | 26 | A |
| P _{tot} | Total Dissipation at T _c = 25 °C | 125 | 45 | W |
| | Derating Factor | 1 | 0.36 | W/°C |
| V _{ISO} | Insulation Withstand Voltage (DC) | — | 2000 | V |
| T _{stg} | Storage Temperature | -65 to 150 | | °C |
| T _j | Max. Operating Junction Temperature | 150 | | °C |

(•) Pulse width limited by safe operating area

THERMAL DATA

| | | TO-220 | ISOWATT220 | | |
|-----------------------|--|--------|------------|------|------|
| R _{thj-case} | Thermal Resistance Junction-case | Max | 1 | 2.78 | °C/W |
| R _{thj-amb} | Thermal Resistance Junction-ambient | Max | 62.5 | | °C/W |
| R _{thc-sink} | Thermal Resistance Case-sink | Typ | 0.5 | | °C/W |
| T _l | Maximum Lead Temperature For Soldering Purpose | | 300 | | °C |

AVALANCHE CHARACTERISTICS

| Symbol | Parameter | Max Value | Unit |
|-----------------|--|-----------|------|
| I _{AR} | Avalanche Current, Repetitive or Not-Repetitive (pulse width limited by T _j max, δ < 1%) | 6.5 | A |
| E _{AS} | Single Pulse Avalanche Energy (starting T _j = 25 °C, I _D = I _{AR} , V _{DD} = 50 V) | 215 | mJ |
| E _{AR} | Repetitive Avalanche Energy (pulse width limited by T _j max, δ < 1%) | 9.5 | mJ |
| I _{AR} | Avalanche Current, Repetitive or Not-Repetitive (T _c = 100 °C, pulse width limited by T _j max, δ < 1%) | 4.3 | A |

ELECTRICAL CHARACTERISTICS (T_{case} = 25 °C unless otherwise specified)

OFF

| Symbol | Parameter | Test Conditions | Min. | Typ. | Max. | Unit |
|----------------------|---|--|------|------|-----------|----------|
| V _{(BR)DSS} | Drain-source Breakdown Voltage | I _D = 250 μA V _{GS} = 0 | 600 | | | V |
| I _{DSS} | Zero Gate Voltage Drain Current (V _{GS} = 0) | V _{DS} = Max Rating V _{DS} = Max Rating x 0.8 T _c = 125 °C | | | 25 250 | μA μA |
| I _{GSS} | Gate-body Leakage Current (V _{DS} = 0) | V _{GS} = ± 30 V | | | ± 100 | nA |

ON (*)

| Symbol | Parameter | Test Conditions | Min. | Typ. | Max. | Unit |
|---------------------|-----------------------------------|---|------|------|------|------|
| V _{GS(th)} | Gate Threshold Voltage | V _{DS} = V _{GS} I _D = 250 μA | 2.25 | 3 | 3.75 | V |
| R _{DS(on)} | Static Drain-source On Resistance | V _{GS} = 10V I _D = 3 A | | 1 | 1.2 | Ω |
| I _{D(on)} | On State Drain Current | V _{DS} > I _{D(on)} x R _{DS(on)max} V _{GS} = 10 V | 6.5 | | | A |

DYNAMIC

| Symbol | Parameter | Test Conditions | Min. | Typ. | Max. | Unit |
|---------------------|------------------------------|--|------|------|------|------|
| g _{fs} (*) | Forward Transconductance | V _{DS} > I _{D(on)} x R _{DS(on)max} I _D = 3 A | 3.5 | 5.6 | | S |
| C _{iss} | Input Capacitance | V _{DS} = 25 V f = 1 MHz V _{GS} = 0 | | 1150 | 1550 | pF |
| C _{oss} | Output Capacitance | | | 155 | 210 | pF |
| C _{rss} | Reverse Transfer Capacitance | | | 40 | 55 | pF |

ELECTRICAL CHARACTERISTICS (continued)

SWITCHING ON

| Symbol | Parameter | Test Conditions | Min. | Typ. | Max. | Unit |
|-------------------------------|--|---|------|---------------|-----------|----------------|
| $t_{d(on)}$ t_r | Turn-on Time Rise Time | $V_{DD} = 300\text{ V}$ $I_D = 3\text{ A}$ $R_G = 47\ \Omega$ $V_{GS} = 10\text{ V}$ (see test circuit, figure 3) | | 35 90 | 50 125 | ns ns |
| $(di/dt)_{on}$ | Turn-on Current Slope | $V_{DD} = 480\text{ V}$ $I_D = 6\text{ A}$ $R_G = 47\ \Omega$ $V_{GS} = 10\text{ V}$ (see test circuit, figure 5) | | 200 | | A/ μ s |
| Q_g Q_{gs} Q_{gd} | Total Gate Charge Gate-Source Charge Gate-Drain Charge | $V_{DD} = 480\text{ V}$ $I_D = 3\text{ A}$ $V_{GS} = 10\text{ V}$ | | 54 8 23 | 75 | nC nC nC |

SWITCHING OFF

| Symbol | Parameter | Test Conditions | Min. | Typ. | Max. | Unit |
|---------------------------------|---|---|------|-----------------|------------------|----------------|
| $t_{r(Voff)}$ t_f t_c | Off-voltage Rise Time Fall Time Cross-over Time | $V_{DD} = 480\text{ V}$ $I_D = 6\text{ A}$ $R_G = 47\ \Omega$ $V_{GS} = 10\text{ V}$ (see test circuit, figure 5) | | 80 20 115 | 110 30 155 | ns ns ns |

SOURCE DRAIN DIODE

| Symbol | Parameter | Test Conditions | Min. | Typ. | Max. | Unit |
|-----------------------------------|--|---|------|----------------|-----------|--------------------|
| I_{SD} $I_{SDM}(\bullet)$ | Source-drain Current Source-drain Current (pulsed) | | | | 6.5 26 | A A |
| $V_{SD} (*)$ | Forward On Voltage | $I_{SD} = 6.5\text{ A}$ $V_{GS} = 0$ | | | 1.6 | V |
| t_{rr} Q_{rr} I_{RRM} | Reverse Recovery Time Reverse Recovery Charge Reverse Recovery Current | $I_{SD} = 6\text{ A}$ $di/dt = 100\text{ A}/\mu\text{s}$ $V_{DD} = 100\text{ V}$ $T_j = 150\text{ }^\circ\text{C}$ (see test circuit, figure 5) | | 600 9 30 | | ns μ C A |

(*) Pulsed: Pulse duration = 300 μ s, duty cycle 1.5 %

(\bullet) Pulse width limited by safe operating area

Safe Operating Areas for TO-220

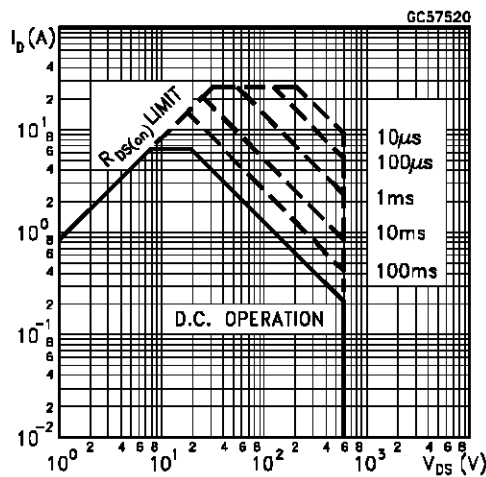

Safe Operating Areas for ISOWATT220

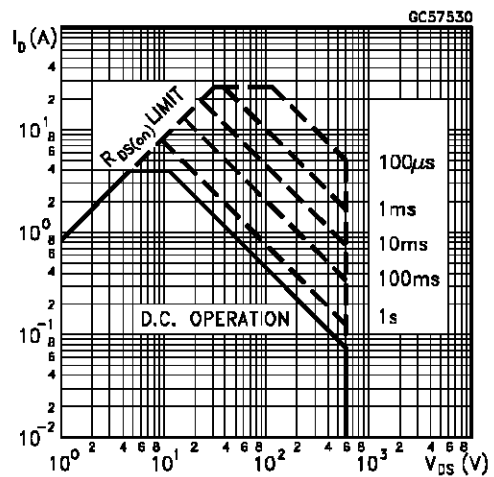

Thermal Impedance For TO-220

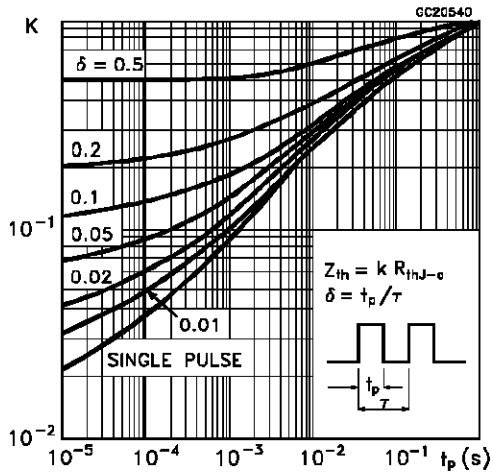

Thermal Impedance For ISOWATT220

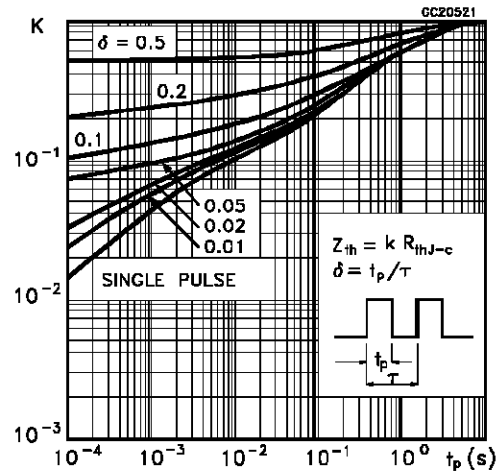

Derating Curve For TO-220

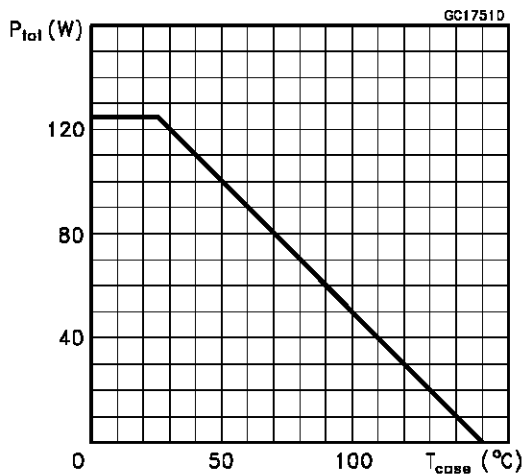

Derating Curve For ISOWATT220

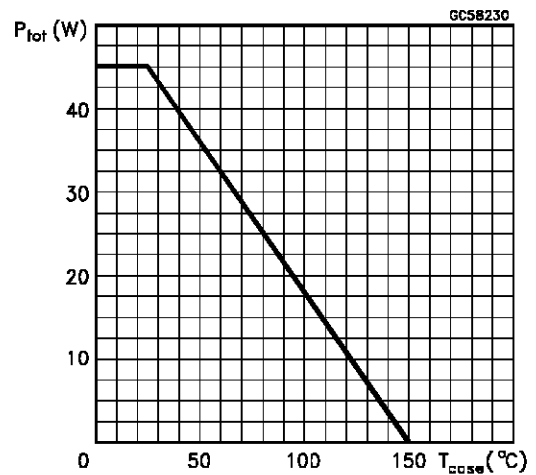

Output Characteristics

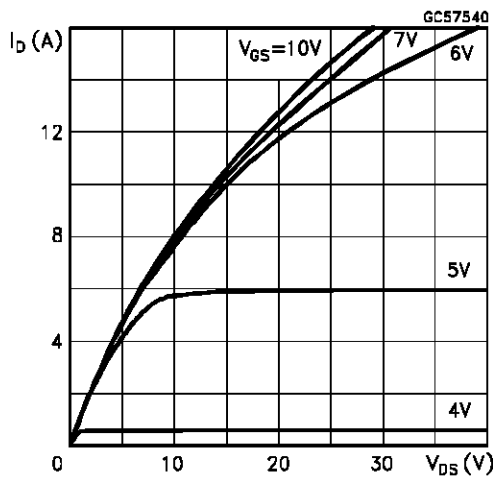

Transfer Characteristics

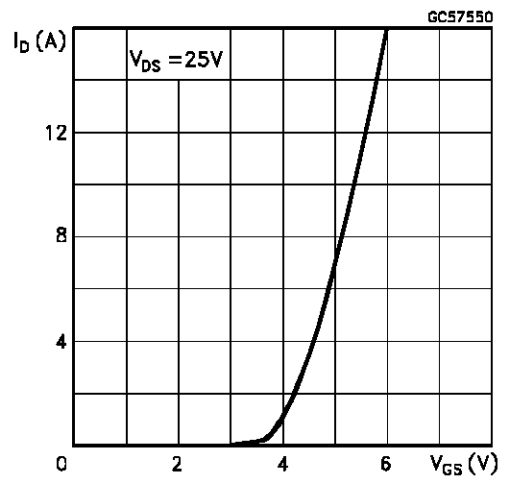

Transconductance

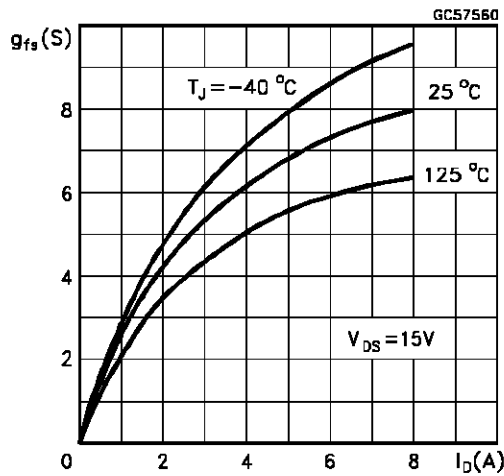

Static Drain-source On Resistance

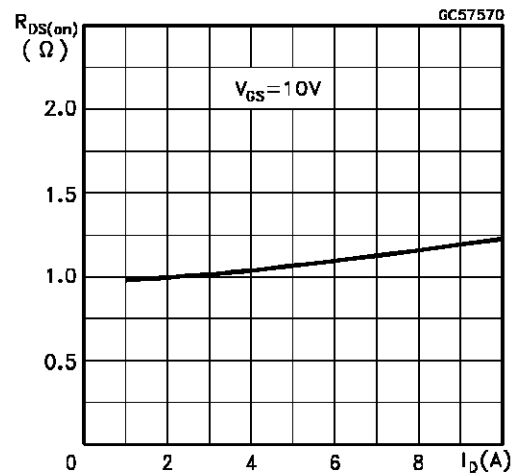

Gate Charge vs Gate-source Voltage

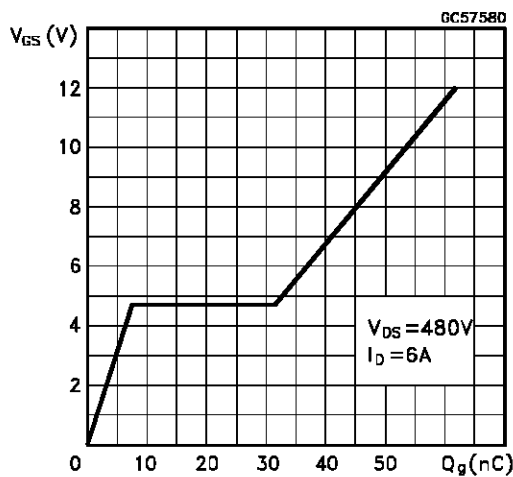

Capacitance Variations

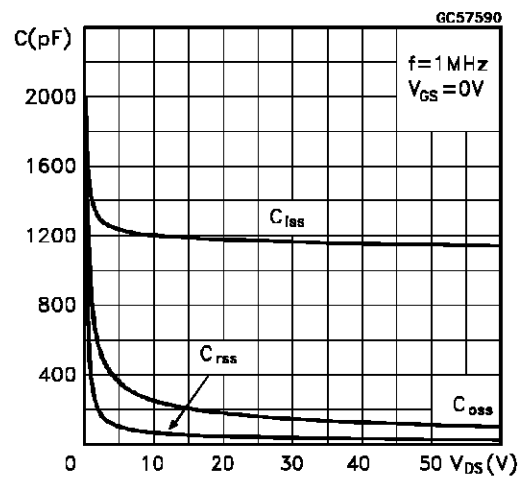

Normalized Gate Threshold Voltage vs Temperature

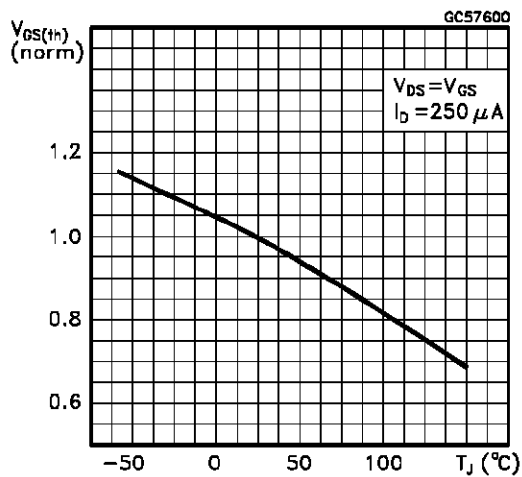

Normalized On Resistance vs Temperature

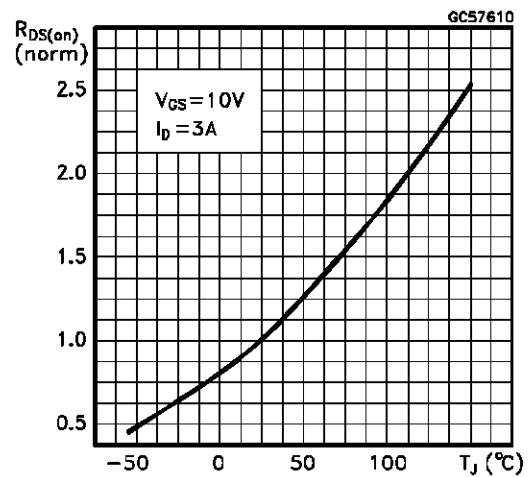

Turn-on Current Slope

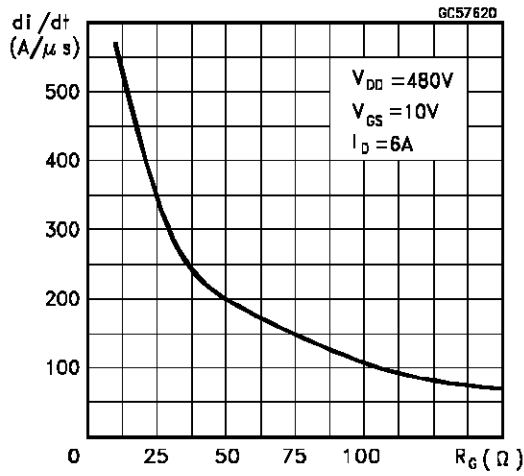

Turn-off Drain-source Voltage Slope

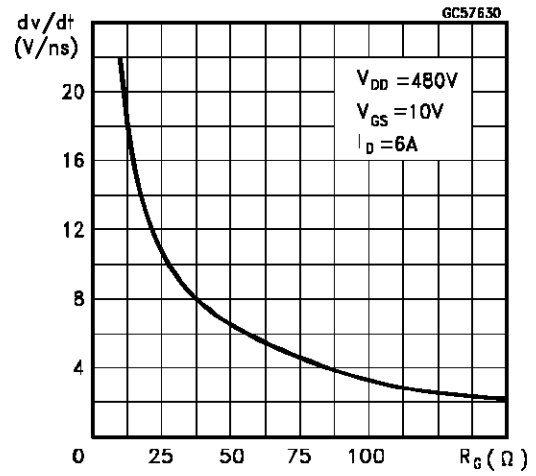

Cross-over Time

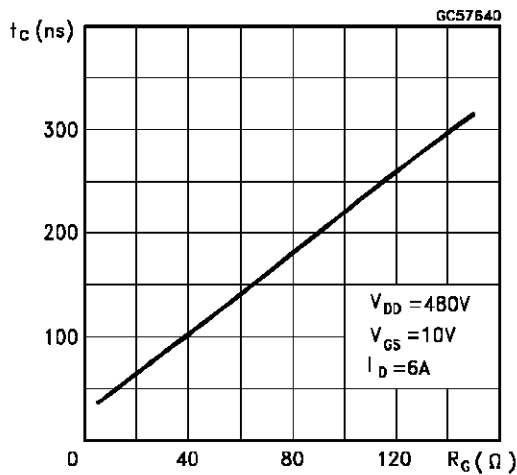

Switching Safe Operating Area

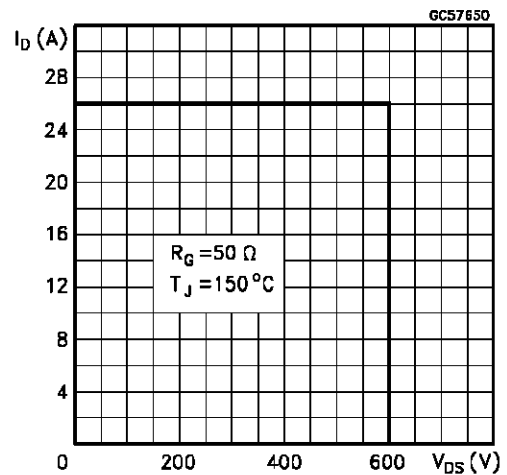

Accidental Overload Area

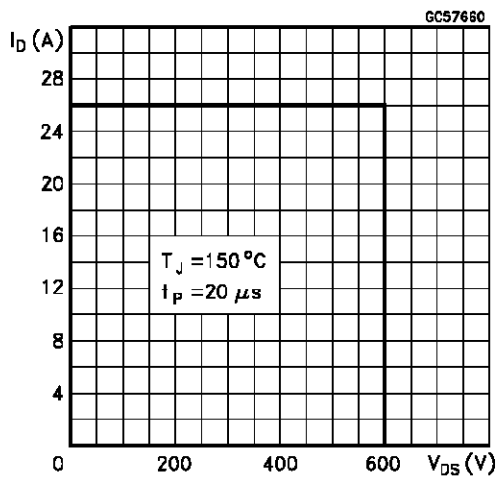

Source-drain Diode Forward Characteristics

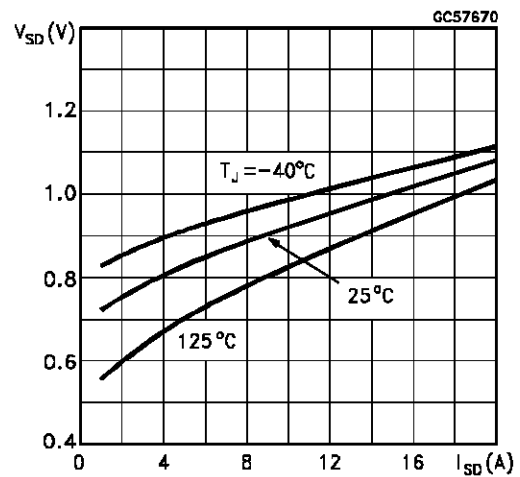

Fig. 1: Unclamped Inductive Load Test Circuits



Fig. 2: Unclamped Inductive Waveforms



Fig. 3: Switching Times Test Circuits For Resistive Load



Fig. 4: Gate Charge Test Circuit

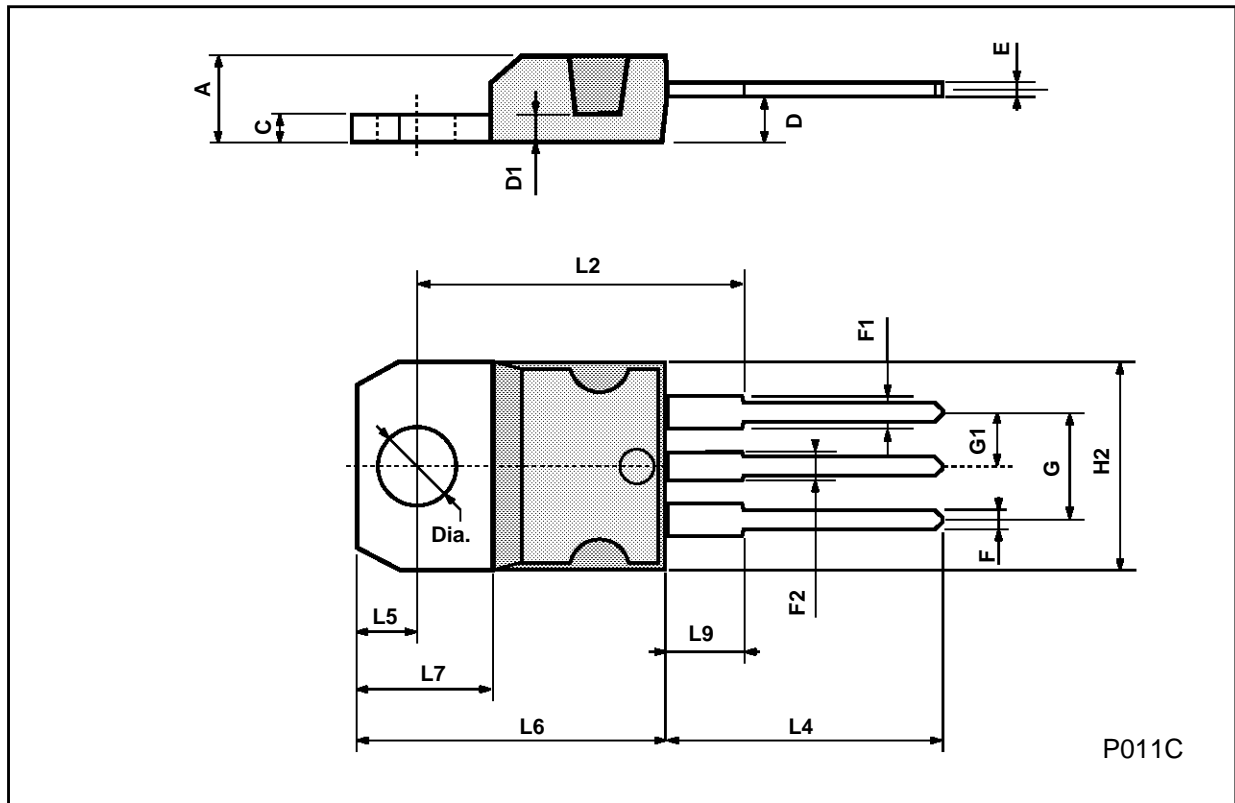

Fig. 5: Test Circuit For Inductive Load Switching And Diode Reverse Recovery Time



TO-220 MECHANICAL DATA

| DIM. | mm | | | inch | | |
|------|-------|------|-------|-------|-------|-------|
| | MIN. | TYP. | MAX. | MIN. | TYP. | MAX. |
| A | 4.40 | | 4.60 | 0.173 | | 0.181 |
| C | 1.23 | | 1.32 | 0.048 | | 0.051 |
| D | 2.40 | | 2.72 | 0.094 | | 0.107 |
| D1 | | 1.27 | | | 0.050 | |
| E | 0.49 | | 0.70 | 0.019 | | 0.027 |
| F | 0.61 | | 0.88 | 0.024 | | 0.034 |
| F1 | 1.14 | | 1.70 | 0.044 | | 0.067 |
| F2 | 1.14 | | 1.70 | 0.044 | | 0.067 |
| G | 4.95 | | 5.15 | 0.194 | | 0.203 |
| G1 | 2.4 | | 2.7 | 0.094 | | 0.106 |
| H2 | 10.0 | | 10.40 | 0.393 | | 0.409 |
| L2 | | 16.4 | | | 0.645 | |
| L4 | 13.0 | | 14.0 | 0.511 | | 0.551 |
| L5 | 2.65 | | 2.95 | 0.104 | | 0.116 |
| L6 | 15.25 | | 15.75 | 0.600 | | 0.620 |
| L7 | 6.2 | | 6.6 | 0.244 | | 0.260 |
| L9 | 3.5 | | 3.93 | 0.137 | | 0.154 |
| DIA. | 3.75 | | 3.85 | 0.147 | | 0.151 |



ISOWATT220 MECHANICAL DATA

| DIM. | mm | | | inch | | |
|------|------|------|------|-------|-------|-------|
| | MIN. | TYP. | MAX. | MIN. | TYP. | MAX. |
| A | 4.4 | | 4.6 | 0.173 | | 0.181 |
| B | 2.5 | | 2.7 | 0.098 | | 0.106 |
| D | 2.5 | | 2.75 | 0.098 | | 0.108 |
| E | 0.4 | | 0.7 | 0.015 | | 0.027 |
| F | 0.75 | | 1 | 0.030 | | 0.039 |
| F1 | 1.15 | | 1.7 | 0.045 | | 0.067 |
| F2 | 1.15 | | 1.7 | 0.045 | | 0.067 |
| G | 4.95 | | 5.2 | 0.195 | | 0.204 |
| G1 | 2.4 | | 2.7 | 0.094 | | 0.106 |
| H | 10 | | 10.4 | 0.393 | | 0.409 |
| L2 | | 16 | | | 0.630 | |
| L3 | 28.6 | | 30.6 | 1.126 | | 1.204 |
| L4 | 9.8 | | 10.6 | 0.385 | | 0.417 |
| L6 | 15.9 | | 16.4 | 0.626 | | 0.645 |
| L7 | 9 | | 9.3 | 0.354 | | 0.366 |
| Ø | 3 | | 3.2 | 0.118 | | 0.126 |



Information furnished is believed to be accurate and reliable. However, SGS-THOMSON Microelectronics assumes no responsibility for the consequences of use of such information nor for any infringement of patents or other rights of third parties which may result from its use. No license is granted by implication or otherwise under any patent or patent rights of SGS-THOMSON Microelectronics. Specifications mentioned in this publication are subject to change without notice. This publication supersedes and replaces all information previously supplied. SGS-THOMSON Microelectronics products are not authorized for use as critical components in life support devices or systems without express written approval of SGS-THOMSON Microelectronics.

© 1996 SGS-THOMSON Microelectronics - Printed in Italy - All Rights Reserved

SGS-THOMSON Microelectronics GROUP OF COMPANIES

Australia - Brazil - Canada - China - France - Germany - Hong Kong - Italy - Japan - Korea - Malaysia - Malta - Morocco - The Netherlands - Singapore - Spain - Sweden - Switzerland - Taiwan - Thailand - United Kingdom - U.S.A